

5 4 3 2 1



D

C

B

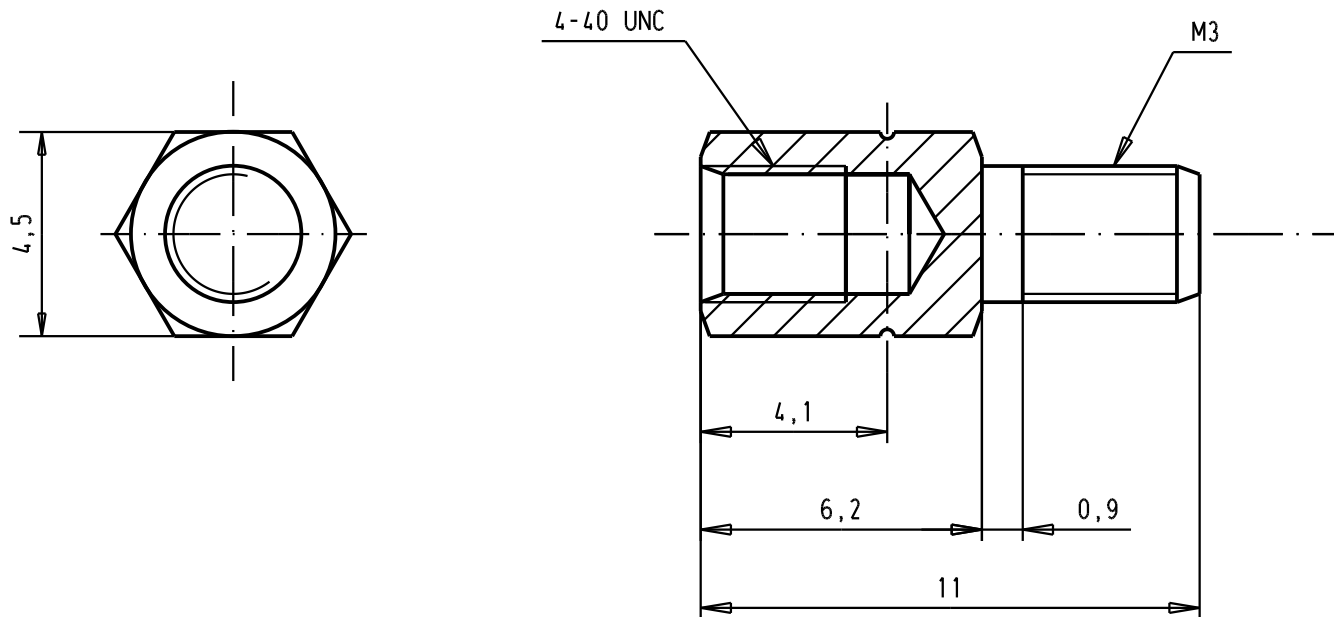
A



32837	14/06/05	ED		Dat.	Name	 All Dim. in mm Orig. Size DIN A 4	D-Sub, Female screw lock UNC 4-40 / M3, nickel plated	Maßstab/ Scale 6:1
31910	27/05/04	JH	Detail.	27/05/04	JH			
29760	28/03/02	CV	Insp.					
23231	28/07/98	PP	Stand.					
21221	18/07/97	MF	HARTING EURL F-95972 Paris				TB 09670009974	Blatt/ Page 1 /
21212	16/04/97	MF						
Mod.	Dat.	Name						
							Sub.	